

Please read through this user's manual to ensure correct usage of the manual setter and keep it handy for quick reference.

Contents

1. Notice	1
2. What is on the Front Panel?	1
3. Installing the Manual Setter	1
4. Panel Cutout Dimensions and External Dimensions	1
5. Wiring	2
6. Hardware Specifications	2
7. Key Operations	3
8. Troubleshooting	3

Revision Record

IM 05F01F12-01E 1st Edition: Feb. '01
2nd Edition: Jun. '04

1. Notice

The following safety symbol is used both on the product and in this user's manual.

This symbol stands for "Handle with Care." When displayed on the product, the operator should refer to the corresponding explanation given in the user's manual in order to avoid injury or death of personnel and/or damage to the product. In the manual the symbol is accompanied by an explanation of the special care that is required to avoid shock or other dangers that may result in injury or loss of life.



The following symbols are used in this manual only.

NOTE Indicates that operating the hardware or software in a particular manner may lead to damage or result in system failure.

IMPORTANT Draws attention to information that is essential for understanding the operation and/or features of the product.

Exemption from Responsibility

Make sure that all of the precautions are strictly adhered to. Yokogawa Electric Corporation assumes no liability for any damage resulting from use of the instrument in contradiction to the precautions.

Also, Yokogawa Electric Corporation assumes no liability to any party for any loss or damage, direct or indirect, caused by the use or any unpredictable defect of the instrument.

2. What is on the Front Panel ?

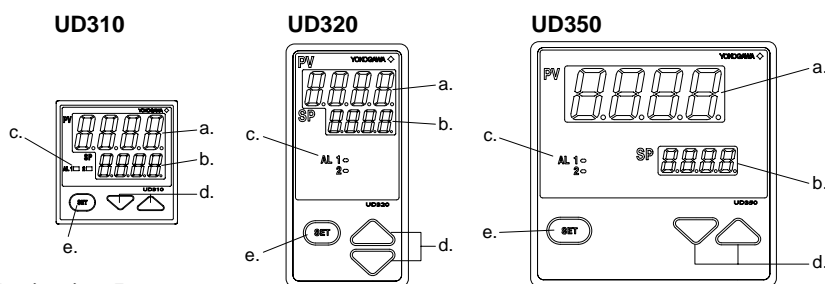

Monitoring Parts

Name	Function
a. PV display (red)	Indicates PV (measured value) and character information such as parameter codes and error codes. PV goes out when the setup parameter "PVD" is set to OFF.
b. SP display (green)	Indicates SP (target setpoint) and character information such as parameter setpoints.
c. AL1, AL2 lamps (red)	AL1 : Lit when alarm 1 is activated. AL2 : Lit when alarm 2 is activated.

Operating Parts (See 7. Key operations)

Name	Function
d. Data change key	<ul style="list-style-type: none"> Changes SP(target setpoint) and the parameter values. Pressing this key increases the data value. SP (target setpoint) will be output in 3 seconds after the change. Holding down the key will gradually increase the speed of changes.
Data change key	<ul style="list-style-type: none"> Changes SP(target setpoint) and the parameter setpoints. Pressing this key decreases the data value. SP (target setpoint) will be output in 3 seconds after the change. Holding down the key will gradually decrease the speed of changes.
e. SET key (parameter data registering key)	<ul style="list-style-type: none"> Registers the parameter setpoint changed using the data change keys. Switches between parameter setting displays sequentially. Pressing the key for 3 seconds or longer in the operating display retrieves the operating parameter setting display. Pressing the key for 3 seconds or longer in operating or setup parameter setting display transfers back to operating display.

3. Installing the Manual Setter

CAUTION

To prevent electric shock, the source of power to the manual setter must be turned off when mounting the manual setter on to a panel.

NOTE

To install the manual setter, select a location where:

- No-one may accidentally touch the terminals;
- Mechanical vibrations are minimal;
- Corrosive gas is minimal;
- The temperature can be maintained at about 23°C with minimal fluctuation;
- There is no direct heat radiation;
- There are no resulting magnetic disturbances;
- The terminal board (reference junction compensation element, etc.) is protected from wind;
- There is no splashing of water; and
- There are no flammable materials.

Never place the manual setter directly on flammable items.

If the manual setter has to be installed close to flammable items or equipment, be sure to enclose the manual setter in shielding panels positioned at least 150mm away from each side. These panels should be made of either 1.43mm thick metal-plated steel plates or 1.6mm thick uncoated steel plates.

- Mount the manual setter at an angle within 30° from horizontal with the screen facing upward. Do not mount it facing downward.

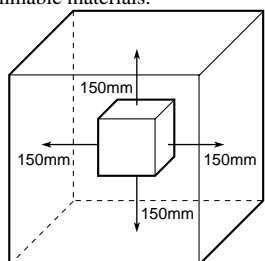
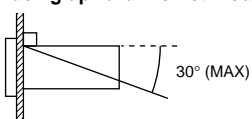

Checking Package Contents

Before using the product, check that its model & suffix codes are as you ordered.

Model and Suffix Codes

Model	Suffix code	Description
UD310		UD310 Manual Setter 4 to 20 mADC output (48×48×100 mm)
UD320		UD320 Manual Setter 4 to 20 mADC output (48×96×100 mm)
UD350		UD350 Manual Setter 4 to 20 mADC output (96×96×100 mm)
Fixed code	-0	Always 0
Fixed code	0	Always 0
Option	/V24	Power Supply 24V DC / 24V AC

* 2 Alarm outputs and PV retransmission output in 4 to 20 mA built in as standard.

Check the package contents against the list below.

- Manual Setter 1
- Mounting bracket 1 for UD310
2 for UD320, UD350
- User's manual (this manual) 1

Yokogawa Electric Corporation
Network Solutions Business Division
2-9-32, Naka-cho Musashino-shi, Tokyo 180-8750 Japan
Phone: +81-422-52-7179 Facsimile: +81-422-52-6793

4. Panel Cutout Dimensions and External Dimensions

1. General Mounting

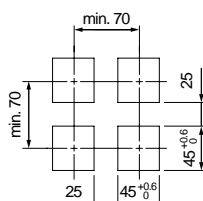

UD310

Unit: mm

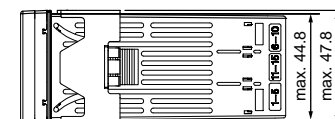

2. Side-by-side Close Mounting

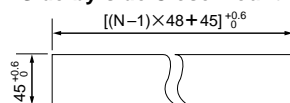

N is the number of manual setters.
If N ≥ 5, then measure the actual length.

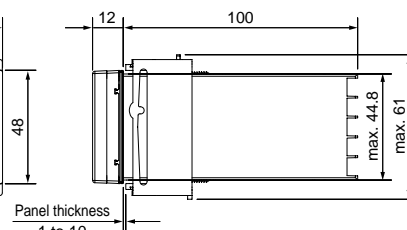
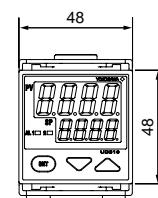

1. General Mounting

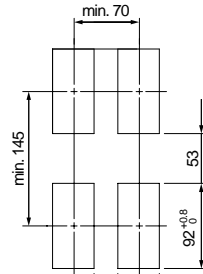

UD320

Unit: mm

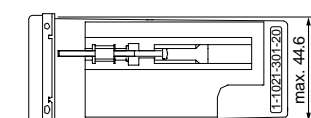

2. Side-by-side Close Mounting

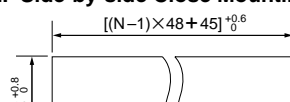

N is the number of manual setters.
If N ≥ 5, then measure the actual length.

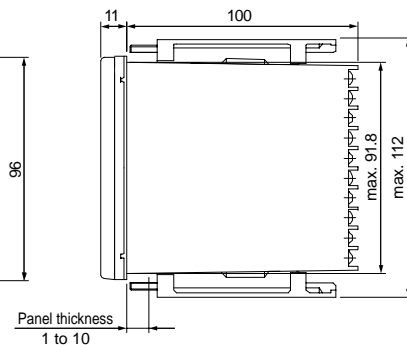
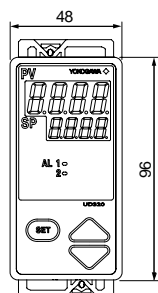

1. General Mounting

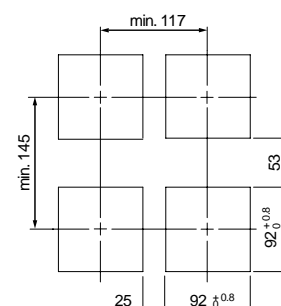

UD350

Unit: mm

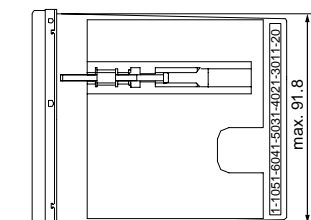

2. Side-by-side Close Mounting

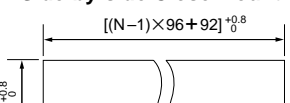

N is the number of manual setters.
If N ≥ 5, then measure the actual length.

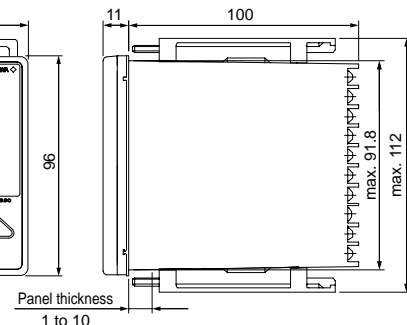
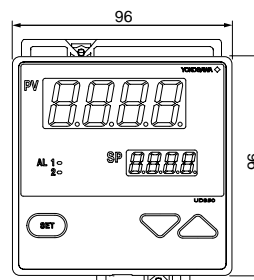

NOTE

Splash-proof construction is not available when the side-by-side close mounting method shown in the above figure, is chosen for any of the manual setters.

Mounting the Manual Setter

UD310

UD310 Bracket

UD320, UD350

Large bracket (top)
Terminal board
Small bracket (bottom)

[How to remove the bracket]
To remove the bracket, push down the center of the upper and lower parts of the manual setter softly. The bracket is released from the latch.

5. Wiring

CAUTION

- Before you start wiring, turn off the power source and use a tester to check that the instrument and cables are not receiving any power in order to prevent electric shock.
- For safety, be sure to install a circuit breaker switch (of 5A and 100V AC or 220V AC, and that conforms to IEC60947) near the instrument so as to be operated easily, and clearly indicate that the device is used to de-energize the instrument.
- Wiring should be carried out by personnel with appropriate electrical knowledge and experience.

NOTE

- Use a single-phase power source. If the source has a lot of noise, use an isolation transformer for the primary side and a line filter (we recommend TDK's ZAC2205-00U product) for the secondary side. When this noise-prevention measure is taken, keep the primary and secondary power cables well apart. Since the manual setter has no fuse, be sure to install a circuit breaker switch (of 5A and 100V AC or 220V AC, and that conforms to IEC standards) and clearly indicate that the device is used to de-energize the manual setter.
- For thermocouple input, use shielded compensating lead wires. For RTD input, use shielded wires which have low resistance and no resistance difference between the 3 wires. See the table given later for the specifications of the cables and terminals and the recommended products.
- The alarm output relay cannot be replaced even though it has a limited service life (100,000 relay contacts for the resistance load). Thus, an auxiliary relay should be used so that the load can be turned on and off.
- When using an inductive load (L) such as an auxiliary relay and solenoid valve, be sure to insert a CR filter (for AC) or diode (for DC) in parallel as a spark-rejecting surge suppressor to prevent malfunctions or damage to the relay.
- When there is the possibility of being struck by external lightning surge, use the arrester to protect the instrument.

Cable Specifications and Recommended Products

Power supply and relay contact output	600V vinyl insulated wire/cable, JIS C3307, 0.9 to 2.0mm ²
Thermocouple input	Shielded compensating lead wire, JIS C1610
RTD input	Shielded wire (3-wire), UL2482 (Hitachi cable)
Other signals	Shielded wire

Recommended Terminals

Use M3.5 screw-compatible crimp-on terminals with an insulating sleeve, as shown below.

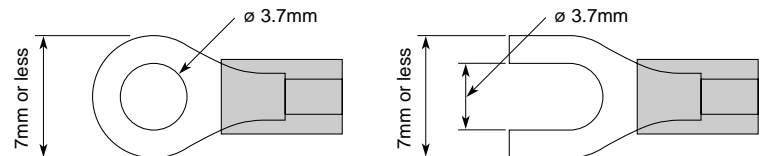

IMPORTANT

Always fix a terminal cover bracket to the UD310 manual setter before wiring if an optional anti-electric-shock terminal cover (part number: L4000FB) is used.

IMPORTANT

Two types of optional anti-electric-shock terminal covers (part numbers T9115YE and T9115YD) are available for the UD320 and UD350 manual setters, respectively.

Model UD310-00 Terminal Arrangement

NOTE
Do not use unassigned terminals as relay terminals.

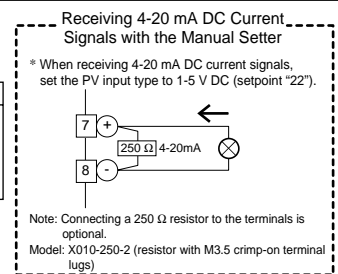
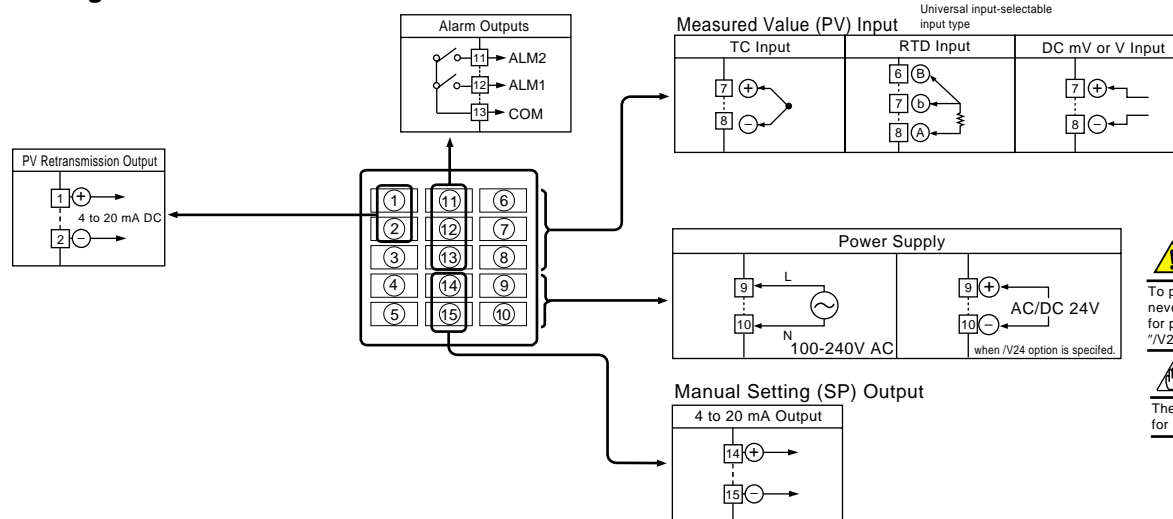

CAUTION
To prevent damage to the manual setter, never provide 100-240V AC power supply for power supply AC/DC 24V model (when "/V24" is specified).

NOTE
The (+) and (-) stand for the polarity for DC 24V power supply.

Models UD320-00/UD350-00 Terminal Arrangement

Note: The terminal arrangements of the UD320 and UD350 are the same.

NOTE
Do not use unassigned terminals as relay terminals.

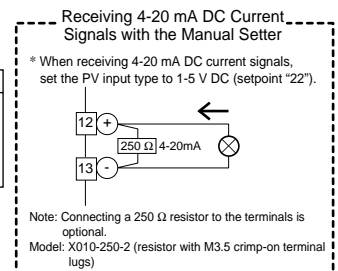
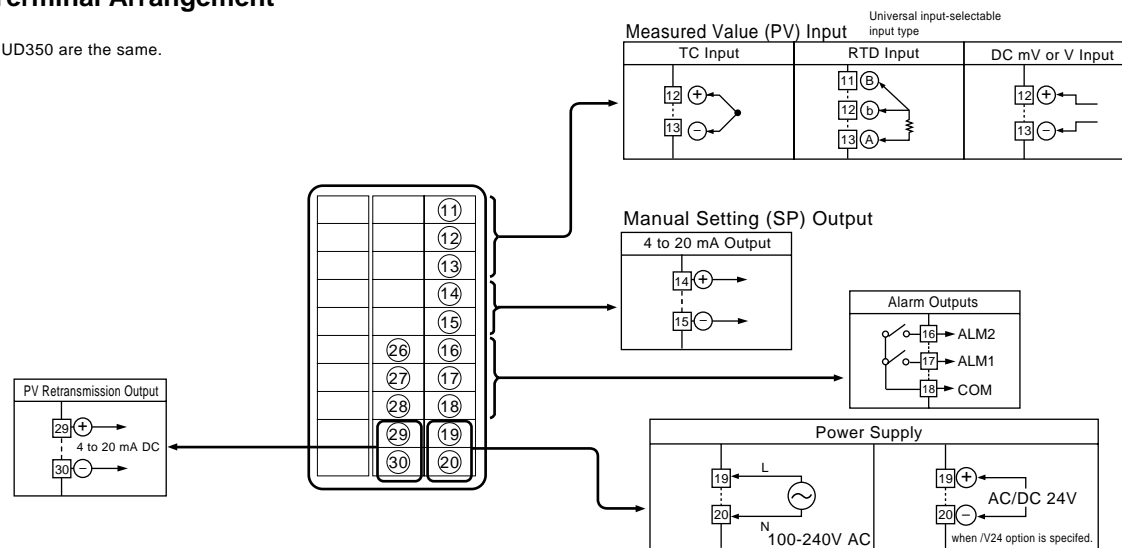

CAUTION
To prevent damage to the manual setter, never provide 100-240V AC power supply for power supply AC/DC 24V model (when "/V24" is specified).

NOTE
The (+) and (-) stand for the polarity for DC 24V power supply.

6. Hardware Specifications

Measured Value (PV) Input

- Input: 1 point
 - Input type: Universal; can be selected by software
 - Input accuracy (at 23 ±2°C ambient temperature)
 - Thermocouple: ±2°C ±1digit
However,
 - ±4°C for thermocouple input -200 to -100°C
 - ±3°C for thermocouple input -100 to 0°C
 - ±5°C for types R and S (±9°C for 0 to 500°C)
 - ±9°C for type B (accuracy is not guaranteed for 0 to 400°C)
 - RTD: ±1°C ±1digit
 - Voltage(mV, V) : ±0.3% ±1digit
 - Sampling period for measured value input: 500ms
 - Burn-out detection: Functions for thermocouple or RTD input (burn-out upscale only; cannot be switched off)
 - Input resistance: 1MΩ or greater for thermocouple or DC mV input. Approx. 1MΩ for DC V input
 - Maximum allowable signal source resistance : 250Ω for thermocouple or DC mV input 2kΩ for DC V input
 - Maximum allowable wiring resistance for RTD input: 10Ω/wire (The resistance values of three wires must be the same.)
 - Allowable input voltage: ±10V DC for thermocouple or DC mV input ±20V DC for DC V input
 - Noise rejection ratio: Normal mode noise: Min. 40dB (50/60Hz) Common mode noise: Min. 120dB (Min. 90dB for DC V input)
 - Error of reference junction compensation: ±1.5°C (at 15-35°C) ±2.0°C (at 0-50°C)
- The reference junction compensation cannot be switched off.
- Applicable standards: Thermocouple and resistance temperature detector (RTD) JIS/IEC/DIN (ITS90)

Manual Setting (SP) Output

- SP (target setpoint) will be output in 3 seconds after the change.
- Output: 1 point
 - Output type: Current output
 - Output signal: 4 to 20mA current output
 - Maximum load resistance: 600Ω
 - Output accuracy: ±0.3% of span (at 23±2°C ambient temperature)

Alarm Functions

- Alarm types: 22 types (waiting action can be set by software): PV high limit, PV low limit, Deviation high limit, Deviation low limit, De-energized on deviation high limit, De-energized on deviation low limit, Deviation high and low limits, Deviation within high and low limits, De-energized on PV high limit, De-energized on PV low limit, Fault diagnosis output, FAIL output
 - Alarm output: 2 relay contacts
 - Relay contact capacity: 1A at 240V AC or 1A at 30V DC (with resistance load) (COM terminal is common)
- Note: The alarm output relays cannot be replaced by users.

Retransmission Output

- Output signal: Measured value in 4-20mA DC, can be scaled.
- Maximum load resistance: 600Ω
- Output accuracy: ±0.3% of span (at 23±2°C ambient temperature)

Safety and EMC Standards

- Safety: Compliant with IEC/EN61010-1: 2001, approved by CSA1010, approved by UL508. Installation category : CAT. II (IEC/EN61010, CSA1010) Pollution degree : 2 (IEC/EN61010, CSA1010) Measurement category : I (CAT. I : IEC/EN61010) Rated measurement input voltage : 10V DC max.(across terminals), 300V AC max.(across ground) Rated transient overvoltage : 1500V (Note) Note : It is a value on the safety standard which is assumed by IEC/EN61010-1 in measurement category I, and is not the value which guarantees an apparatus performance. Caution: This equipment has Measurement category I, therefore do not use the equipment for measurements within measurement categories II, III and IV.
- EMC standards: Complies with EN61326. The instrument continues to operate at a measuring accuracy of within ±20% of the range during tests.

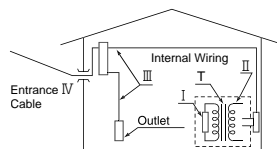

Measurement category	Description	Remarks
I	CAT. I For measurements performed on circuits not directly connected to MAINS.	
II	CAT. II For measurements performed on circuits directly connected to the low voltage installation.	Appliances, portable equipments, etc.
III	CAT. III For measurements performed in the building installation.	Distribution board, circuit breaker, etc.
IV	CAT. IV For measurements performed at the source of the low-voltage installation.	Overhead wire, cable systems, etc.

Power Supply and Isolation

Power supply	Voltage	Rated at 100-240VAC (±10%) AC/DC 24V, 20 to 29V of allowable range when "/V24" is specified.
	Frequency	50 or 60Hz
Maximum power consumption		8VA max. (4W max.) 3W max. when "/V24" is specified.
Memory		Non-volatile memory
Withstanding voltage	Between primary terminals and secondary terminals (See Notes 1 and 2.)	1500V AC for 1 minute
Insulation resistance	Between primary terminals and secondary terminals (See Notes 1 and 2.)	20MΩ or more at 500V DC

Note 1: The primary terminals are the power supply terminals and alarm output terminals.
The secondary terminals are the analog input and output terminals.
Note 2: AC/DC 24V terminals are secondary terminals.

Isolation
The bold lines below indicate reinforced isolation, and the broken line indicates functional isolation.

Power supply terminals (100-240V AC)	Power supply terminals AC/DC 24V (When "/V24" is specified)
Alarm output terminals (2 relay contacts)	Measured value input terminals
	Internal circuit
	Manual setting output terminals : 4-20 mA
	Retransmission output terminals : 4-20 mA

Note: The measured value input terminals is isolated from the internal circuit.

Construction, Mounting, and Wiring

- Construction: Dust-proof and drip-proof front panel conforming to IP65 [Model UD310] and IP55 [Models UD320 and UD350]. For side-by-side close installation the controller loses its dust-proof and drip-proof protection.
- Casing: ABS resin and polycarbonate
- Case color: Black
- Weight: UD310 - approx. 200g UD320 - approx. 300g UD350 - approx. 400g
- Mounting: Flush panel mounting
- Wiring: Screw terminals

Environmental Conditions

- Normal Operating Conditions
 - Warm-up time: At least 30 minutes
 - Ambient temperature: 0-50°C (0-40°C when mounted side-by-side)
 - Rate of change of temperature: 10°C/h or less
 - Ambient humidity: 20-90% RH (no condensation allowed)
 - Magnetic field: 400A/m or less
 - Continuous vibrations of 5 to 14Hz: Amplitude of 1.2mm or less
 - Continuous vibrations of 14 to 150Hz: 4.9m/s² (0.5G) or less
 - Short-period vibrations: 14.7m/s² (1.5G) for 15 seconds or less
 - Shock: 98m/s² (10G) for 11 milliseconds or less
 - Mounting angle: Upward incline of up to 30 degrees; downward incline is not allowed.
 - Altitude: 2000m or less above sea level
- Maximum Effects from Operating Conditions
 - Temperature effects
 - Thermocouple, DC mV and DC V input: ±2μV/°C or ±0.02% of F.S./°C, whichever is larger
 - Resistance temperature detector: ±0.05°C/°C
 - Analog output: ±0.05% of F.S./°C
 - Effect from fluctuation of power supply voltage (within rated voltage range)
 - Analog input: ±0.2μV/V or ±0.002% of F.S./V, whichever is larger
 - Analog output: ±0.05% of F.S./V
- Transportation and Storage Conditions
 - Temperature: -25 to 70°C
 - Humidity: 5 to 95% RH (no condensation allowed)
 - Shock: Package drop height 90cm (when packed in the dedicated package)

7. Key Operations



To prevent electric shock, the manual setter should be mounted on the panel so as not to accidentally touch the terminals when power is being applied.

- You can move between parameter setting displays using the **SET** key.
- To change the parameter setpoint,
 - Change the display value with the **▽** or **△** key (the period flashes).
 - Press the **SET** key to register the setpoint.
- In the operating display, pressing the **SET** key for at least 3 seconds retrieves the operating parameter setting display.
- In the operating parameter setting display, pressing the **SET** key for at least 3 seconds transfers back to the operating display.
Registering the key-lock parameter LOC to “-1” retrieves the setup parameter setting display.
- In the setup parameter setting display, pressing the **SET** key for at least 3 seconds transfers back to the operating display.



Changing certain setup parameters may automatically initialize the operating parameters. Therefore, after you change the setup parameters, always check the operating parameter setpoints to find out if appropriate values have been set for them. If the operating parameters have been initialized, set them to their appropriate values.



At power-on, the manual setter displays the operating display, but if the measured input type setting remains OFF, “IN” appears. In this case, press the **△** key to display the measured input range code you want to use, then press the **SET** key to register it. (Refer to the flowchart below.)

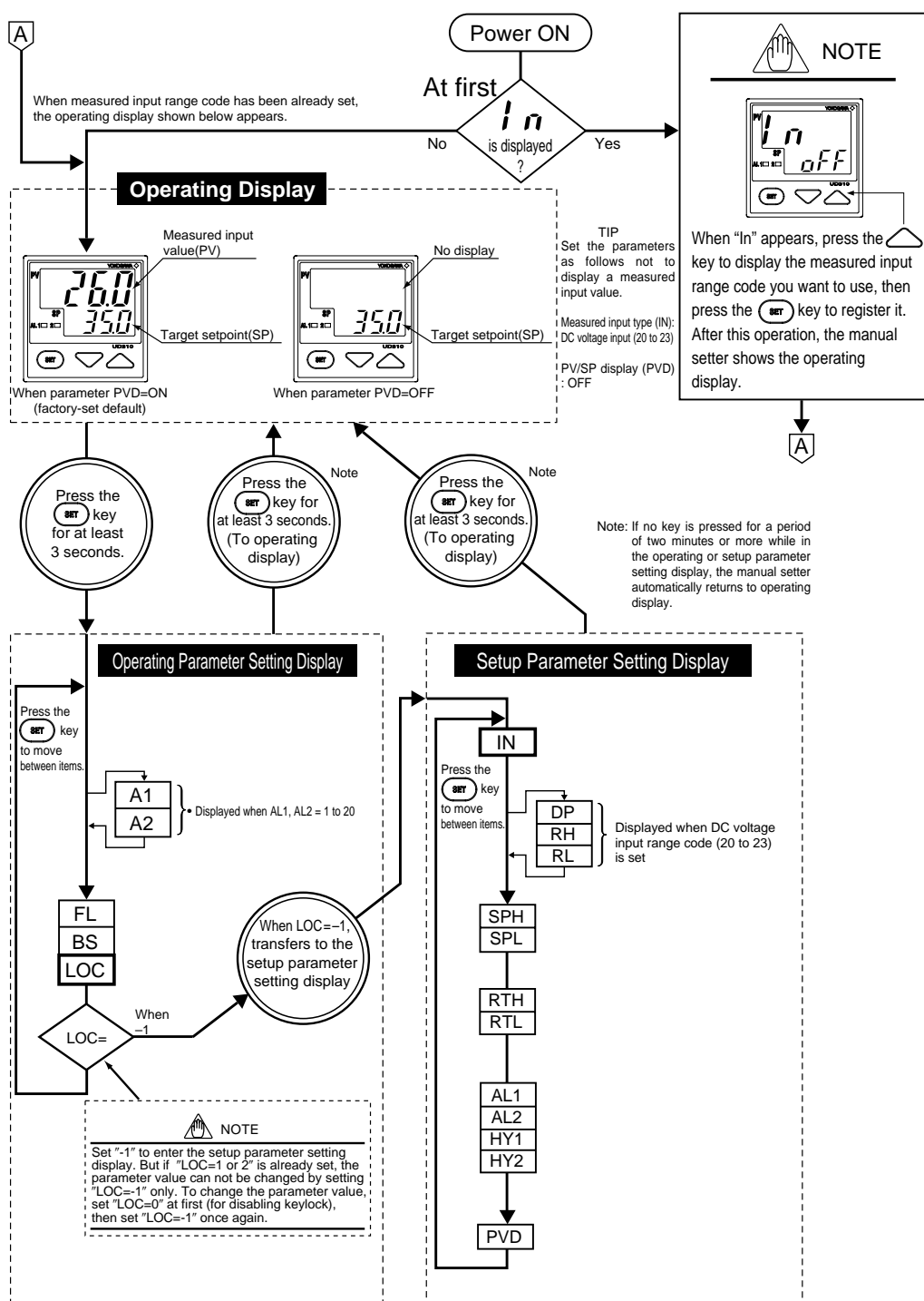

UD310/UD320/UD350 Measured Input Type and Ranges

Input type	Range (°C)	Range code (°C)	Range (°F)	Range code (°F)
Unspecified		OFF		
Thermocouple	K	1	-270 to 1370°C	31
		2	0.0 to 600.0°C	32
		3	0.0 to 400.0°C	33
		4	-199.9 to 200.0°C	34
	J	5	-199.9 to 999.9°C	35
	T	6	-199.9 to 400.0°C	36
	E	7	-199.9 to 999.9°C	37
	R	8	0 to 1700°C	38
	S	9	0 to 1700°C	39
	B	10	0 to 1800°C	40
	N	11	-200 to 1300°C	41
	L	12	-199.9 to 900.0°C	42
	U	13	-199.9 to 400.0°C	43
RTD	Pt100	14	0 to 1390°C	44
		15	-199.9 to 850.0°C	45
	JPt100	16	0.0 to 1300°C	46
		17	-199.9 to 200.0°C	47
		18	-19.9 to 99.9°C	48
		19	-199.9 to 500.0°C	
DC voltage	0 to 100mV	20	0.0 to 100.0	
		21	0.000 to 5.000	
	0 to 5V	22	1.000 to 5.000	
		23	0.00 to 10.00	

For example, to select thermocouple type J (°F), set the range code to 35.



The manual setter is shipped with the parameters set at the factory-set defaults. Check the default values against the “Parameter Lists” in the following page, and change the parameter setpoints that need to be changed.

This section explains how to set and register parameter setpoints.

The procedure for changing Target Setpoint(SP) and Alarm 1 Setpoint(A1) can be found on “Changing Target Setpoint(SP)” and “Changing Alarm 1 Setpoint(A1)”.

You can set the other parameters in the same way.

Changing Target Setpoint (SP)

The following instructions assume that the manual setter is already receiving power.
SP (target setpoint) value will be output in 3 seconds after the change.

Step 1:

Confirm that the manual setter shows the operating display during normal operation (PV and SP are displayed on the indicators).

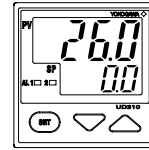

Step 2:

Press the **▽** or **△** key to change the SP display value to the required setpoint. In this example, SP is changed to 200°C.



Changing Alarm 1 Setpoint (A1)

Check alarm type before setting the alarm setpoint.
Factory-set settings:
Alarm 1 type : OFF
Alarm 2 type : OFF

Step 1:

Confirm that the manual setter shows the operating display during normal operation (PV and SP are displayed on the indicators).

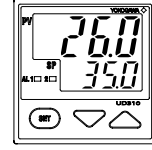

Step 2:

To enter the operating parameter setting display, press the **SET** key for at least 3 seconds.

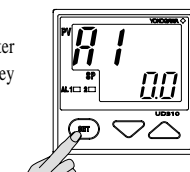

Press for at least 3 seconds.

Step 3:

Press the **▽** or **△** key to change the current A1 setpoint to a required setpoint. In this example, A1 is changed to 200°C.

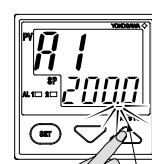

The period flashes while the setpoint is being changed.

Step 4:

Press the **SET** key once to register the setpoint. The period goes out. A1 is now changed. Another press of the **SET** key calls up the Alarm 2 setpoint(A2) display. To return to the operating display, press the **SET** key for at least 3 seconds.

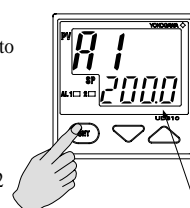

The period goes out.

8. Troubleshooting

In the event of an abnormality, perform the following checks as outlined by the flowchart.

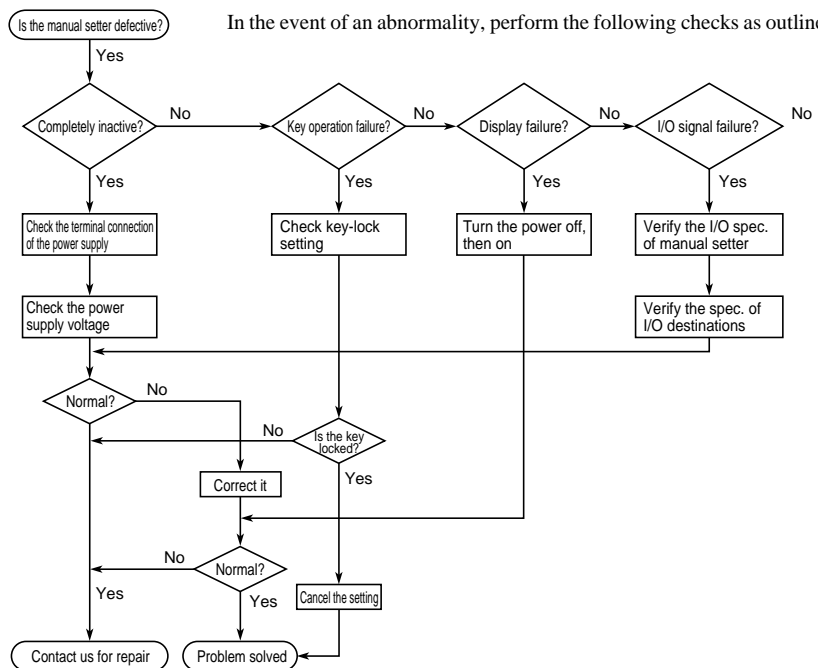

Error Display during Operation

(1) If the manual setter displays one of the following, carry out the appropriate remedy for the particular error.

Display	Error content	Remedy
P.Er	P.Er The parameter is abnormal	Check the setpoints of all the parameters and set them at their proper values.
b.o	B.o Input burnout	Check the sensor wiring and correct it. Not display when the setup parameter PVD=OFF.
000	OOO PV over-scale (PV exceeds its effective range.)	Check the measured input type and scale settings and correct them.
UUU	UUU PV under-scale (PV falls below its effective range.)	Not display when the setup parameter PVD=OFF.
No PV display		Set the setup parameter PVD=ON to display PV.

(2) The manual setter needs to be repaired if any of the indications in the table below appear.

In these cases, do not try to repair the manual setter yourself.

Order a new manual setter or contact us for repair.

Display	Error content	Display	Error content
Unknown (at power-on)	CPU failure	Flashing “Err” (at power-on)	RAM or ROM failure
All extinguished (at power-on)	Power source failure	Flashing “Err” (during operation)	A/D converter failure, RJC failure, or EEPROM failure
“Err” (at power-on)	Calibration abnormal		

When Power Failure Occurred during Operation

● Momentary power failures shorter than 20ms(or shorter than 1ms when “/V24” is specified) have no effect on the manual setter operation (i.e., normal operation continues).

● For power failures of 20ms or longer(or 1ms or longer when “/V24” is specified), however the status will be as follows.

(The manual setter action at power recovery is the same as at power-on.)

• Alarm action: Continues (but alarms with a waiting action enter the waiting state once)

• Setting parameters: Maintained

Parameter Lists

(1) Operating Parameters : Parameters changed rather frequently during operation.

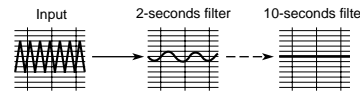
Code	Name	Setting range and unit	Default	User setting
A1	Alarm 1 setpoint	<ul style="list-style-type: none"> PV alarm Unit: °C/°F Setting range: [minimum value - (maximum value - minimum value)] to maximum value of measured input range (scale) 	Depends on the alarm 1 type.	
A2	Alarm 2 setpoint	<ul style="list-style-type: none"> Deviation alarm Unit: °C/°F Setting range: -100 to 100% of the measured input range (scale) span 	Depends on the alarm 2 type.	
FL	PV input filter	OFF, 1 to 120 seconds This function should be used when the PV display value may fluctuate greatly, for example, when the measured input signal contains noise. The filter is of the first-order lag type, and FL sets the time constant. If a larger time constant is set, the filter can remove more noise. 	OFF	
BS	PV input bias	-100 to 100% of measured input range (scale) span This function adds a bias value to the measured input value, and the result is used for display and retransmission output. $PV \text{ value inside the manual setter} = \text{measured input value} + PV \text{ input bias}$ This function is useful for carrying out fine adjustment when the PV value is within the required accuracy but it differs from the value obtained by other equipment.	0% of measured input range (scale) span	
LOC	Key lock	0: No key lock 1: Prevents parameter from being changed of except for SP in the operating display. 2: Prevents all parameter changing operations including SP in the operating display. -1: Set "-1" to enter the setup parameter setting display. But if "LOC=1 or 2" is already set, the parameter value can not be changed by setting "LOC=-1" only. To change the parameter value, set "LOC=0" at first (for disabling keylock), then set "LOC=-1" once again.	0	

(2) Setup Parameters : Parameters rarely changed in normal use after once having been set.

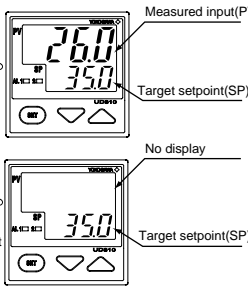
Code	Name	Setting range and unit	Default	User setting
IN	Measured input type	1 to 23, 31 to 48 (See input range code list.) OFF: No input (If no input type is specified at the time of ordering, you must set the input type.)	OFF, or the input range code specified with order	
DP	Decimal point position of measured input	0: No decimal place (nnnn) (Displayed at voltage input) 1: One decimal place (nn.n) 2: Two decimal places (nn.nn) 3: Three decimal places (n.nnn)	1	
RH	Maximum value of measured input scale	(RL + 1) to 9999 (Displayed at voltage input)	100.0	
RL	Minimum value of measured input scale	-1999 to (RH - 1) (Displayed at voltage input)	0.0	
SPH	Maximum value of target setpoint range (Setpoint for manual setting output 20mA)	SPH setting range: (SPL+1 digit) to the maximum value of the measured input range (scale) ; Unit: °C/°F SPL setting range: Minimum value of the measured input range (scale) to (SPH - 1 digit) ; Unit: °C/°F	Maximum value of measured input range (scale)	
SPL	Minimum value of target setpoint range (Setpoint for manual setting output 4mA)	Target setpoint range (Factory-set default) Target setpoint range (after scaling) Manual setting output (4 to 20mA)	Minimum value of measured input range (scale)	
RTH	Maximum value of retransmission output	Voltage input : (RTL+1 digit) to max. value of measured input scale (RH) Min. value of measured input scale (RL) to (RTH-1 digit) However, RTL < RTH	Maximum value of measured input range (scale)	
RTL	Minimum value of retransmission output	Retransmission range (Factory-set default) Retransmission range (after scaling) Retransmission output (4 to 20mA)	Minimum value of measured input range (scale)	
AL1	Alarm 1 type	OFF or a value from 1 to 22 (see the table of alarm function list), and either	OFF	
AL2	Alarm 2 type		OFF	
HY1	Alarm 1 hysteresis	0.0 to 100.0% of measured input range (scale) span Unit: °C/°F	0.5% of measured input range (scale) span	
HY2	Alarm 2 hysteresis		0.5% of measured input range (scale) span	
PVD	PV/SP display	ON: Displays PV (measured input) and SP (target setpoint) OFF: Displays SP (target setpoint) 	ON	

Description of Measured Input

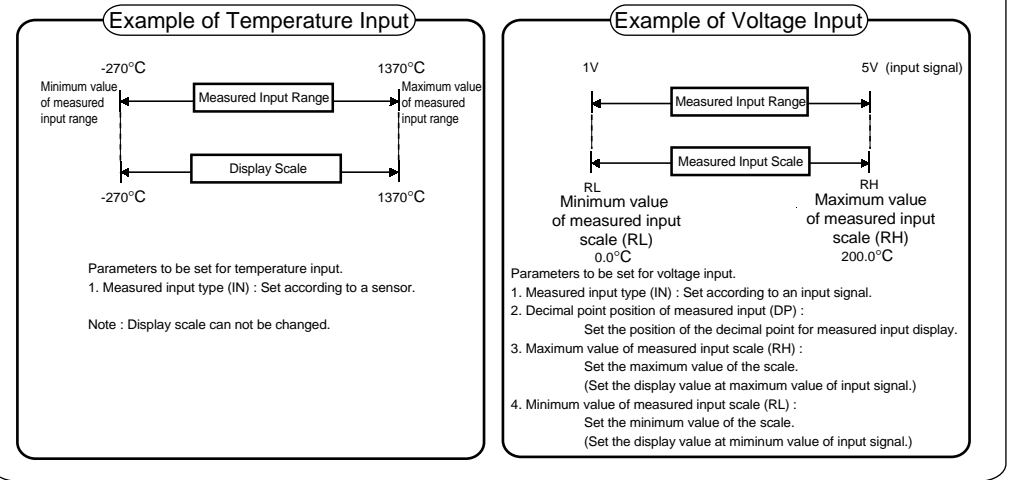

Description of Alarm Functions

Alarm Function List

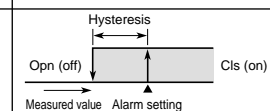
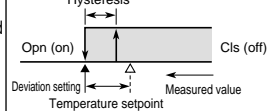
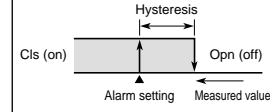
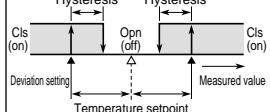
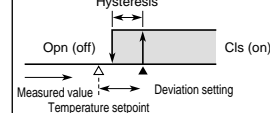
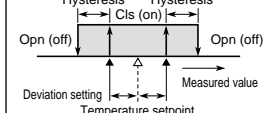
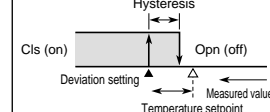
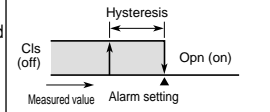
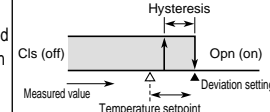
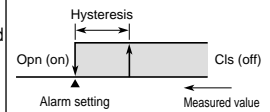
Alarm type	Action	Alarm type code	Alarm type	Action	Alarm type code
	("On" and "Cl" indicate that the relay contact is opened and closed; "on" and "off" indicate that the lamp is on and off; and white triangles indicate temperature setpoints.)	Closed contact during alarm / Open contact during alarm		("On" and "Cl" indicate that the relay contact is opened and closed; "on" and "off" indicate that the lamp is on and off; and white triangles indicate temperature setpoints.)	Closed contact during alarm / Open contact during alarm
No alarm		OFF			
PV high limit		1 / 11 (See note.)	De-energized on deviation low limit		6 / 16 (See note.)
PV low limit		2 / 12 (See note.)	Deviation high and low limit		7 / 17 (See note.)
Deviation high limit		3 / 13 (See note.)	Deviation within high- and low-limit		8 / 18 (See note.)
Deviation low limit		4 / 14 (See note.)	De-energized on PV high limit		9 / 19 (See note.)
De-energized on deviation high limit		5 / 15 (See note.)	De-energized on PV low limit		10 / 20 (See note.)
Fault diagnosis alarm	The contact is closed at input burnout.	21	FAIL output	The output contact is opened in the following events: <ul style="list-style-type: none"> Program error ROM error RAM error A/D converter error R/C error EEPROM error power failure 	22

Note: The alarms numbered 1 to 10 have no waiting action, while alarms 11 to 20 have a waiting action. The waiting action turns off the PV and deviation alarms that occur from the start of the control operation until a stable state is reached.

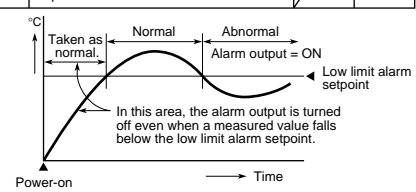

Description of Alarm hysteresis

